



## Universal Pipe Cutters: Service Bulletin

Applies to: 07510, 07511, 07512, 07513, 07517, 07518

FOR ANY QUESTIONS ABOUT THE UPC, CALL REED PRODUCT DEVELOPMENT:  
800-666-3691 or +1-814-452-3691.

**IMPROVING CUTTING SPEED:** While in most cases the REED UPC will cut ductile iron pipe several times faster than self-feeding powered cutters costing several times as much, the following conditions can have a significant impact.

- A. **INSUFFICIENT AIR PRESSURE/VOLUME.** Many compressors do not put out high enough pressure, or enough volume, to allow the unit to operate with proper blade speed. Set Regulator to 90 psi. Also need minimum 50 cfm.
- B. **MAINTAIN 3/4" BORE SIZE THROUGH ALL THE AIR FITTINGS.** One small bore fitting in the air will restrict the volume of air.
- C. **KEEP THE RPMS UP.** Use light feed pressure. Frost on the exhaust ports indicates the motor is in the proper range.
- D. **DO NOT BLOCK THE MOTOR EXHAUST.** Aim the exhaust away from pipe and the operator. Loosen 2 set screws at back side of motor bracket to redirect.
- E. **TEST TRACK THE CUTTER ONE FULL REVOLUTION BEFORE ENGAGING THE BLADE.** Tracking off at an angle will cause the blade to bind, and reduce cutting speed.
- F. **KEEP DIAMOND BLADE SHARP** with a dressing stick or even a brick. In the case of ductile iron pipe that is cement lined, the slurry created by cement, iron and water helps keep a diamond blade dressed.
- G. **OBSERVE PROPER DIRECTION OF BLADE ROTATION.** Assemble the blade to the motor arbor with the label facing toward you. A comet tail behind the diamond particles is an indicator of the direction the blade is running.
- H. **OBSERVE THE LUBRICATION INSTRUCTIONS.** Grease lightly after each day's use. Turn the unit over and rotate the exhaust shield to expose grease fitting through 1/4" hole. Grease and grease gun are provided with each UPC. Also pour a teaspoon of AIR LUBE in the air inlet before each new air hookup and after each day's use.
- I. **VERY THICK OR OLD CAST IRON PIPES.** In some cases these pipes prove to be slow cutting due to the large amount of blade engagement or the pipe may be very hard. The UPDIA6C (#97524) blade is effective on thick/old cast iron.

KEEP LINE PRESSURE FROM BINDING THE BLADE. Use wedges every 4" - 6".

KEEP MOTOR BRACKET LOCK KNOB TIGHT WHEN CUTTING.



FOR ANY QUESTIONS ABOUT THE UPC, CALL REED PRODUCT DEVELOPMENT:  
800-666-3691 or +1-814-452-3691.

- A. ENTER THE CUT SLOWLY. Fast feeding will raise the two rollers off of the pipe and the blade can enter at an angle, stall the motor, or pull the unit off track. The larger the diameter the pipe, the more important it is to feed slowly when making the entry cut.
- B. CUT OFF AT LEAST 4" OF PIPE. Smaller sections, although saving pipe, provide no resistance for the blade to stay in line. (Only applies to PVC.)
- C. GUIDE THE UNIT IN LINE WITH THE CHAIN. Pulling right or left on the handle can make the cutter go off track.
- D. BE SURE BLADES ARE SHARP. Dress/sharpen per Service Bulletin, page 5.
- E. THE ROLLERS SHOULD BE TIGHT BUT FREE TO TURN. Tighten axle nut to reduce endplay. Keep axles and roller bushing oiled with WD-40® or equivalent.
- F. THE TURNBUCKLE ROD END SHOULD FIT BETWEEN CHAIN LINK WITHOUT ENDPLAY. Squeeze together if necessary and use grip ring pliers to adjust out endplay between outside rollers. Keep axle oiled with WD-40 or equivalent. Replace Grip Rings #30131, if not tight.
- G. ENSURE THE MOTOR IS POSITIONED EVENLY IN THE REAR OPENING OF THE MOTOR BRACKET. Use the set screws to adjust left or right. These screws are not for clamping - DO NOT overtighten.
- H. TIGHTEN THE MOTOR BRACKET LOCK KNOB TO FEED THE BLADE. A loose lock knob may allow the cutter to start cutting off at an angle. Feed the blade to penetrate the pipe wall by 1/4".

### PREVENTIVE MAINTENANCE NUMBERS

UPOIL	97583	Air Line Oil, 16 oz. bottle
UPDRESS	97595	DIA. Blade Dress Stick 6 x .75
UPGREASE	97588	Motor Grease, 2 oz. Tube
UPWEDGE	97589	Wedges, set of 20

FOR ANY QUESTIONS ABOUT THE UPC, CALL REED PRODUCT DEVELOPMENT: 800-666-3691 or +1-814-452-3691.

Pneumatic motors are subject to wear, rust and sludge if not maintained properly. While some compressors may be equipped with an oiler or other conditioning device, the Filter-Regulator-Lubricator sold with the UPC is specifically tailored to the need of the unit's high speed motor.

- A. USE FM AIR LUBE AA\*. This product mixes with water and via the UPC lubricator is introduced as a mist in the airstream providing lubrication fairly quickly. Use 6 drops per minute to start.
- B. POUR A TABLESPOON OF AIR LUBE IN THE MOTOR AIR INLET PORT AFTER EACH DAY'S USE. This will protect the internal motor parts from corrosion. DO NOT flush with kerosene or other solvents for any reason.
- C. POUR A TEASPOON OF AIR LUBE IN THE MOTOR PRIOR TO EACH HOOK UP. This assures lubrication until air lube arrives. DO NOT use kerosene or any other solvent that would wash away necessary lubricant.

- D. GREASE THE PLANETARY GEARS AFTER EACH DAY'S USE. Inside the 1/4" hole at the front of the motor exhaust collar is a grease fitting. This fitting should be facing you when turning the unit upside down. If you see an Allen set screw instead of a grease fitting, loosen mounting bolts, rotate motor 180°, and retighten mounting bolts.

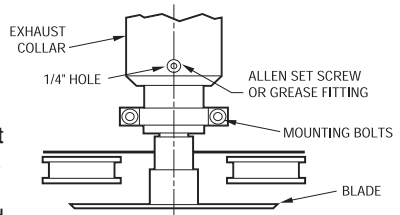

- E. USE THE FILTER-REGULATOR-LUBRICATOR UNIT PROVIDED. The air motor is sensitive to contamination and requires clean air and proper lubrication. Be certain the filter is not clogged and the lubricator has oil and is operating. Any good grade oil is vastly superior to nothing. It is strongly recommended to use FM AIR LUBE AA, 10W/NR, suitable winter and summer.
- F. FIND THE LOCATION OF THE FLUID DRAIN AT THE BOTTOM OF THE COMPRESSOR TANK AND REMOVE THE WATER! Removing the water from the air compressor decreases the amount of water going to the air motor. Water is extremely detrimental to air motors. When air is compressed, it builds up heat. When this warm compressed air expands in the air motor, it cools and the water condenses, causing rust and corrosion. This affects proper operation of the governor, subjecting the motor to premature failure and costly repairs, plus time lost while out of service.

\*FM AIR LUBE AA is a product of Fuchs Lubricants Co., Harvey, Illinois.

FOR ANY QUESTIONS ABOUT THE UPC, CALL REED PRODUCT DEVELOPMENT:  
800-666-3691 or +1-814-452-3691

## DIAMOND BLADES FOR CUTTING CAST IRON & DUCTILE IRON.

The greatest problems users have encountered is with any cast iron that is usually thicker and not cement-lined, which will cause blades to glaze over and stop cutting if water coolant is stopped. REED's diamond blade has been successfully tested to effectively

Catalog No.	Item Code	Description	Pipe Diameter	Application	Arbor Size in mm
UPCDIA6	97525	6" UPC BLADE, Diamond Grit Edge, cut up to 1 23/32" (43.7 mm) wall thickness	8" - 48" (200-1300 mm)	Cast Iron, Pit Cast, Clay, Ductile Iron, Concrete	5/8 15.87
UPCDIA4	97529	4" UPC BLADE, Diamond Grit Edge, cut up to 23/32" (18.3 mm) wall thickness	6" - 8" (150-200 mm)	Cast Iron, Pit Cast, Ductile Iron, Clay, Concrete	5/8 15.87

cut the aforementioned, very-tough-cutting cast iron. REED diamond blades are equally good for cutting ductile iron pipe.

**NOTE:** Water is recommended for cutting both ductile iron and cast iron.

**TEST FOR DETERMINING IF PIPE IS DUCTILE IRON.** Take a medium flat file and file a small flat spot anywhere on the surface of the pipe. Then rub the spot or breathe heavily on the freshly filed spot. If it is ductile iron, it will have a distinctly putrid smell. Cast iron gives off no odor at all.

## DIAMOND BLADE SHARPENING A DIAMOND BLADE NEEDS TO BE DRESSED IF -

1. There is noticeable loss of cutting speed, and
2. There are numerous empty dark craters on edge of blade, and very few or no exposed diamond particles.\*
3. The blade edge appears shiny and corners rounded. Please use only the following procedure to dress a Diamond Blade with a dressing stick. (If you don't have a dressing stick, any concrete brick will serve the same purpose.)

1. Mount the UPC on a pipe.
2. Tighten the turnbuckle to prevent rotation of the unit.
3. Position the blade to clear the pipe.
4. Lock the swing guard in the open position, exposing the blade.
5. Stand looking into the blade side of the unit.
6. To allow dressing debris to exit the area, position dressing stick around the 7 o'clock position as operator faces the blade.

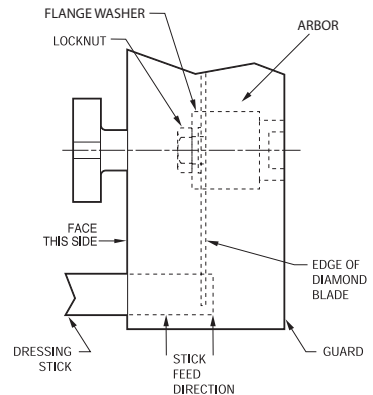

TOP VIEW

FOR ANY QUESTIONS ABOUT THE UPC, CALL REED PRODUCT DEVELOPMENT:  
800-666-3691 or +1-814-452-3691

**WARNING - NEVER STAND IN LINE WITH THE BLADE.**

7. Cover eyes with protective goggles to protect eyes from flying abrasive particles and turn the unit "ON".



8. Feed the stick crossways into the blade (See above). Leave enough stick on the backside of the blade (about 1/8") so it will simultaneously dress both sides of the blade.
  9. Feed slowly and cut off the stick.
  10. Repeat this process - two cuts should dress the blade to expose more diamond.
  11. **WARNING: NEVER PUT FINGERS INSIDE BLADE GUARD. HIGH SPEED ROTATING BLADE CAN CAUSE SERIOUS INJURY.** When stick is about 3" long, use a pair of pliers until the length is reduced to approximately 2", then it should be discarded. ALWAYS use blade guard when powering the motor, including during blade dressing.
- \* **NOTE:** It may be useful to look through a magnifying glass or 8X loupe to see blade edge particles more clearly.

FOR ANY QUESTIONS ABOUT THE UPC, CALL REED PRODUCT DEVELOPMENT:  
800-666-3691 or +1-814-452-3691

## CUTTING STEEL PIPE WITH THE UPC

The UPC can be used to cut steel and stainless steel pipe.  
Max pipe wall thickness for cutting steel .5 inches  
Max pipe wall thickness for cutting stainless steel is .375 inches  
The UPC is not recommended for cutting hardened steel pipe

### BLADES FOR CUTTING STEEL

97519 – 4" BLADE cut up to 1/2" (12.7 mm) STEEL wall thickness 5/8" arbor  
97520 – 6" BLADE cut up to 1/2" (12.7 mm) STEEL wall thickness 5/8" arbor

### USE OF WATER WHEN CUTTING STEEL PIPE

The UPC can cut steel and stainless-steel pipe without using water. When cutting without water the volume of sparks produced during the cut is increased.

Water can be used during the cut to reduce the volume of sparks produced during the cut. Even with the use of water there will be sparks.  
Testing has shown that using water while cutting steel pipe reduces the blade life slightly.



### WHEN CUTTING PIPE THAT CARRIES FLAMMABLE LIQUID OR GAS

The UPC produces sparks when cutting steel pipe.  
ALL flammable liquid or gas must be removed, and the lines completely purged before using the UPC.

DO NOT USE the UPC if there is any flammable liquid or gas in the pipe. If operator suspects the pipe may contain flammable liquid or gas DO NOT use the UPC to make the cut.

### CAUTION:

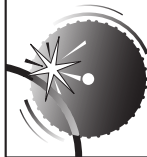

When cutting steel, ductile iron, or cast iron, the UPC can produce sparks. When cutting PE, the UPC may cause a build-up of static electricity. Do not use the UPC saw in-line on potentially explosive or otherwise dangerous situations. The line must be verified as completely purged of any flammable vapor or liquid.



FOR ANY QUESTIONS ABOUT THE UPC, CALL REED PRODUCT DEVELOPMENT:  
800-666-3691 or +1-814-452-3691

## UPC PE MODELS

<i>Model</i>	<i>Part #</i>	<i>Pipe capacity</i>
UPC836APE	07517	8 – 36 (200-1300 mm)
UPC848APE	07518	8 – 48 (200-1300 mm)

## PE CUTTING BLADES

#97519 Carbide-tipped 4" BLADES cut up to 23/32" (18.3 mm) PE wall thickness and 6" – 8" (150-200 mm) pipe diameter

#97520 Carbide-tipped 6" BLADES cut up to 1 23/32" (43.7 mm) PE wall thickness and 8" – 48" (200-1300 mm) pipe diameter

#97521 Carbide-tipped 8" BLADES cut up to 2 23/32" (69 mm) wall thickness and 26" – 48" (660-1300 mm) pipe diameter

### WHEN CUTTING PE PIPE:

There is no need to use water when cutting PE pipe. Turn the exhaust collar on the back of the UPC straight up so the exhaust is blowing straight up and not onto the pipe. Use a hose from the compressor to the FRL and a new hose (if practical) from the FRL to the UPC itself. By using a new hose, oil coming through can be significantly reduced. Users should also wipe off the exhaust collar on a regular basis so there is not a build-up of oil or dripping oil. Also, clear the FRL filter of debris before cutting PE.

### CAUTION:

When cutting PE, the UPC may cause a build-up of static electricity. Do not use the UPC cutter in-line on potentially explosive or otherwise dangerous situations. The line must be verified as completely purged of any flammable vapor or liquid.

FOR ANY QUESTIONS ABOUT THE UPC, CALL REED PRODUCT DEVELOPMENT:  
800-666-3691 or +1-814-452-3691.

## CHANGEOUT PROCEDURE

Remove cutting blade and bevel cutter (if any). Using the wrenches supplied with the UPC, locate the 3/4" nut at the front face of the motor, and the 7/8" flats of the arbor, and unscrew the arbor. Screw new arbor onto motor end and tighten. If you have the arbor for cutting and beveling, replace standard arbor with long arbor and set-up for Cutting and Beveling PVC. Install the flange washer with the relieved edge toward the blade. Add the nut and tighten. Replace the Blade Guard.

## PROPER UPC BLADE ASSEMBLY

**WARNING** - Improper blade assembly will result in blade damage and personal injury. Follow the instructions below.

### 1. SHORT ARBOR

- A. SEAT BLADE CORRECTLY. See illustrations. Visually inspect to be certain the blade is seated on the arbor shoulder and flush against the face of the arbor.
- B. INSTALL FLANGE CORRECTLY. The flange provided with each arbor is relieved on one side. Install the flange with relieved side against the blade.
- C. ADD THE ARBOR LOCKNUT AND TIGHTEN.
- D. REINSTALL BLADE GUARD.

## ASSEMBLY SEQUENCE FOR ARBOR CHANGEOUT

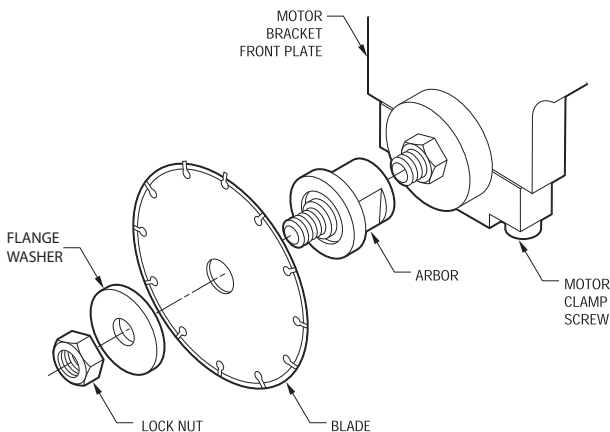

**ARBOR ASSEMBLY FOR CUTTING ONLY**





PIPE TOOLS & VISES  
SINCE 1896

# Cut & Bevel PVC Set-Up

## Installation of REED bevel cutter and blade for PVC



97561 UPCLA Long Arbor



97511 UPCBPVC  
PVC Bevel Cutter



1. Start with base motor unit



2. Tighten Long Arbor onto motor unit

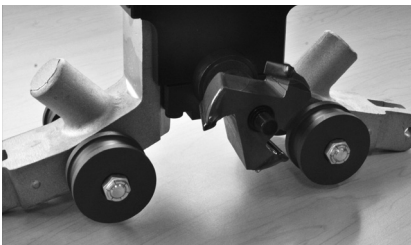

3. Tighten PVC Bevel Cutter onto Long Arbor



4. Add blade for PVC



5. Slide on 97066 Flanged Washer and then tighten 97543 Flexloc Nut

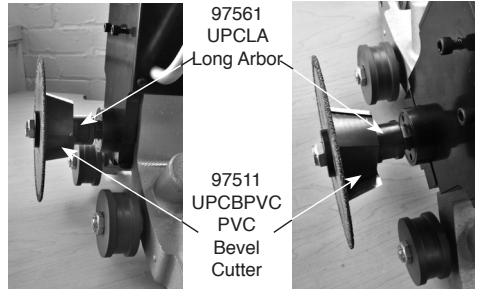

6. Add Blade Guard Assembly

FOR ANY QUESTIONS ABOUT THE UPC, CALL REED PRODUCT DEVELOPMENT:  
800-666-3691 or +1-814-452-3691.

**2. LONG ARBOR, FOR CUTTING AND BEVELING PVC PIPE**

**A. INSTALL BEVEL CUTTER**

Slide the bevel cutter onto the arbor back to a positive stop. See illustration.

**B. SEAT BLADE CORRECTLY.** See illustration.

Visually inspect to be certain blade is seated on the arbor shoulder and flush against the bevel cutter.

**C. INSTALL FLANGE WASHER CORRECTLY.**

The flange washer provided is relieved on one side. Install the flange washer with the relieved side against the blade.

**D. ADD THE LOCKNUT AND TIGHTEN.**

**E. REINSTALL BLADE GUARD**

**WARNING - High speed rotating blades. Personal injury can occur if hands are not kept clear of blades. Always wear proper eye and ear protection. Make sure Blade Guard is properly installed before powering motor.**

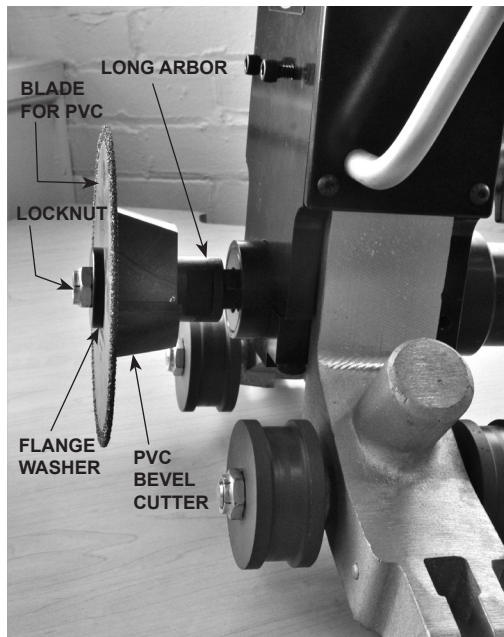

**ARBOR ASSEMBLY FOR CUTTING AND BEVELING PVC IN ONE PASS**



### Warranty And Disclaimer On DOTCO Model 24-1312N-60 Motor

Cooper warrants products and parts sold by it, insofar as they are of its own manufacture, against defects of material and workmanship, under normal use and service in accordance with its written instructions, recommendations, and ratings for installation, operation, maintenance, and service of products for a period of one year from the date of initial use, provided this use is within one year from date of shipment from Reed Manufacturing or its authorized distributor. Proof of purchase with shipment date must be furnished by the user to validate the warranty. This warranty applies only to products manufactured by Cooper and specifically excludes products manufactured by others. Products not manufactured by Cooper are warranted only to the extent and in the manner warranted to Cooper by the manufacturer and then only to the extent Cooper is able to enforce such warranty. This warranty is limited to the repair regarding which the distributor has given written notice to Cooper/DOTCO. Installation and transportation costs are not included. Cooper shall have the option of requiring the return prepaid. No allowances will be made for repairs without Cooper's approval. This warranty of only the Air Motors is extended by Cooper to the end user. All warranty claims for this Air Motor are to be made directly to DOTCO in Hicksville, Ohio. Mailing Address: P.O. Box 182. Shipping Address: Ohio Route 18 East, Hicksville, OH 43526. Phone: (419) 542-7711.

Cooper makes no other warranty of any kind whatsoever, expressed or implied and all warranties of merchantability and fitness for a particular purpose are hereby disclaimed by it.

### Limitation of Liability

Neither Cooper nor Reed shall in any way be liable for special, indirect, incidental, or consequential damages including but not limited to loss of business profits or opportunities, downtime of manufacturing plants or machinery, or loss of good will.



600 Defiance Avenue  
Hicksville, OH 43526  
Phone: (419) 542-7711  
Fax: (419) 542-7330

AIRETOOL® • APEX® • ASSEMBLY SYSTEMS™ • BUCKEYE® • CLECO® • COOPER AUTOMATION • DGD • DOLER™  
• DOTCO® • GARDNER-DENVER® • GARDOTRANS™ • GETA • KOTTHAUS+BUSCH® • MASTER POWER® • METRONIX  
• QUACKENBUSH® • RECOULES • ROTOR TOOL® • STUHR® • UTICA®

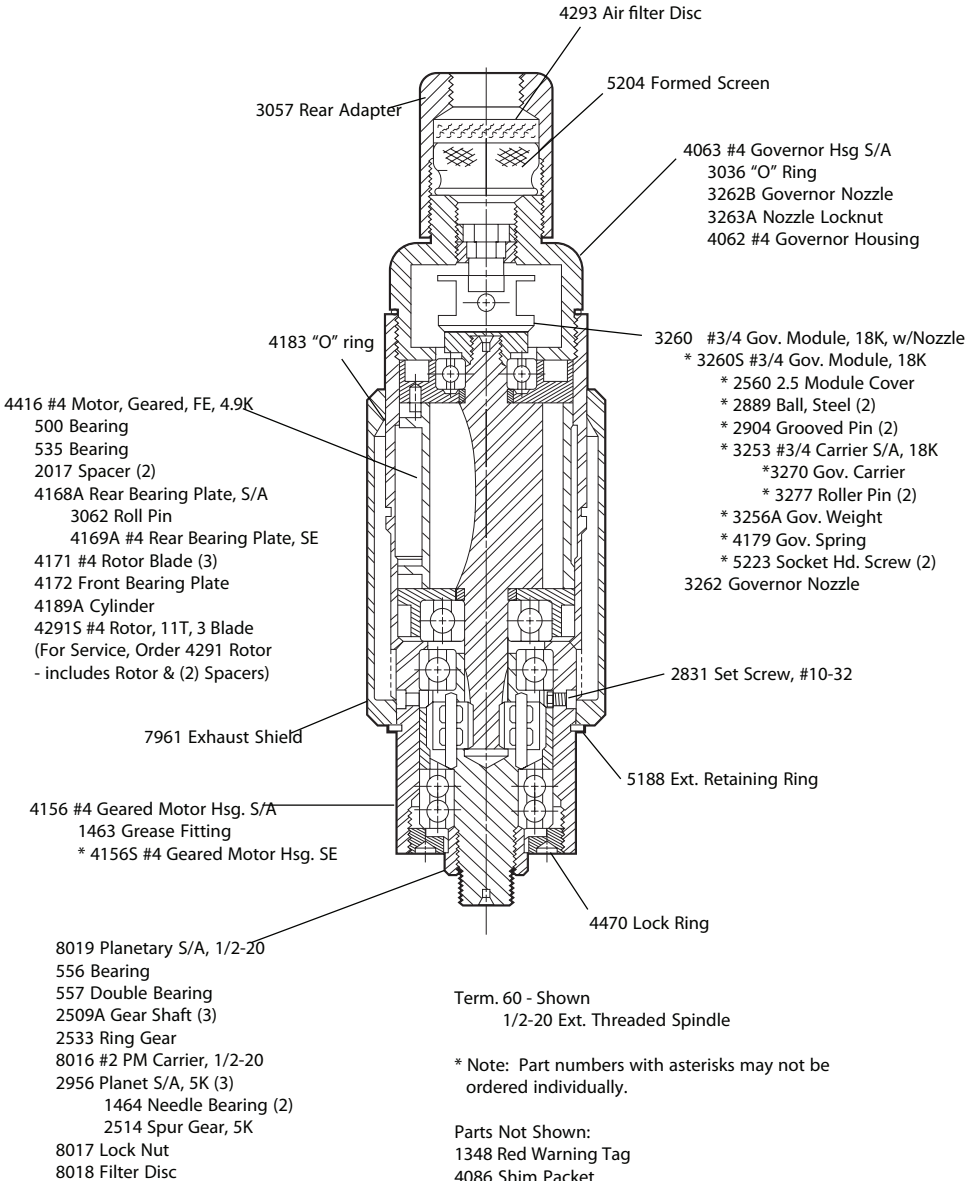

Term. 60 - Shown  
1/2-20 Ext. Threaded Spindle

\* Note: Part numbers with asterisks may not be ordered individually.

Parts Not Shown:  
1348 Red Warning Tag  
4086 Shim Packet

Unless Otherwise Specified:  
Remove all burrs and break sharp edges .01 x 45° max.



# DOTCO Installation & Service Instructions

## Safety Instructions and Warning

### Pneumatic Models

24-1312N-60, 3675 RPM

DOTCO Portable and Mountable Tools are air powered. USE THIS POWER PROPERLY FOR PERSONAL SAFETY. ALWAYS COMPLY WITH:

1. General Industry Safety & Health Regulations, Part 1910, OSHA 2206, available from: Sup't. of Documents, Gov't. Printing Office, Washington, D.C. 20402
2. Safety Code for Portable Air Tools — ANSI B186.1 available from: American National Standards Institute, Inc., 1430 Broadway, New York, New York 10018.
3. State and Local Regulations.

Portions of the above abbreviated below for quick reference to some of the most important regulations. THESE REGULATIONS ARE NOT ALL INCLUSIVE - STUDY AND COMPLY WITH ALL REGULATIONS.

1. Tool Speed Check - Before mounting any abrasive wheel, buffing wheel, wire brush, saw blade, flap wheel, or other product, after all tool repairs and whenever a tool is issued for use, the RPM shall be checked with a tachometer to insure that its actual speed does not exceed rated speed. GOVERNED TOOLS, IN USE ON THE JOB, SHALL BE CHECKED AT LEAST ONCE EVERY TWENTY HOURS OF USE, OR ONCE WEEKLY, WHICHEVER IS MORE FREQUENT.
2. Tool Intent - Tools shall be used only for purposes intended in their design (refer to product catalog).
3. Air Supply - Test and operate tools at 90 PSIG maximum unless tool is marked otherwise. Use recommended air-line filters-regulators-lubricators.
4. Unusual Sound or Vibration - If tool vibrates or produces an unusual sound, repair immediately for correction.
5. Speed Rating of Wheels, etc. - Speed rating of abrasive wheel, wire brush, saw blade, flap wheel, or other products used, must equal or exceed speed rating of tool.
6. Mounting of Wheels, etc. - Each type of wheel, wire brush, saw blade, flap wheel, and other product, has specific mounting procedures and regulations concerning spindles, flanges, blotters, collets, etc., which shall be used. REFER TO REGULATIONS AND/OR WHEEL MANUFACTURERS' INSTRUCTIONS.
7. Wheel Guards - Select proper guards for application and mount securely and properly. SEE REGULATIONS.
8. Inspection of Wheels, etc. - Regularly inspect all wheels, etc., and discard cracked, chipped or otherwise damaged units. Redress out-of-balance wheels. SEE REGULATIONS.
9. Operator Protective Equipment - Wear goggles or face shield at all times tool is in operation. Other protective clothing shall be worn, if necessary, for spark protection deflection. SEE REGULATIONS.
10. Safety Maintenance Program - Employ a safety program to provide inspection and maintenance of all phases of tool operation and air supply equipment in accordance with "Safety Code for Portable Air Tools."

**WARNING!! FAILURE TO COMPLY WITH THESE SAFETY REGULATIONS MAY RESULT IN SERIOUS INJURY.**

**INSTALLATION:** Air pressure of 90 pounds per square inch is recommended for best performance. Pipings, fittings, and hose should be of size adequate to maintain this pressure at the tool, while the tool is in operation. An airline oiler and filter should be used. The hose should be blown out to remove dirt particles and sludge before attaching it to the tool. Set air line regulator gauge at 90 psig. maximum.

**LUBRICATION:** The motor must be lubricated and free of moisture. An air line filter-lubricator-regulator-gauge such as DOTCO No. 45-0540A will take care of the complete lubrication of the tool. We recommend a high grade spindle oil such as SAE No. 5 or DOTCO Oil No. 45-0918, using two or three drops of oil per minute.

**LOSS OF POWER:** Seldom is it necessary to dismantle this tool for loss of power. First, check air line pressure. It should be 90 PSI at or near the tool, while the tool is running. Check the size of the hose and fittings to be certain they are not causing air restrictions. Make certain the hose and fittings are not plugged with rust, dirt or scale. Flush out motor as described below.

**SERVICE INSTRUCTIONS:** Do not squeeze tool or parts in vise except as specified in assembly or disassembly instructions. Bearings are of the shield type. Care must be used in their assembly and disassembly. When pressing bearings onto a shaft, press only on inner race. When pressing bearings into a bore, press only on outer race. (CAUTION: Bearings are lubricated by the bearing manufacturer for the life of the bearing. DO NOT CLEAN WITH SOLVENT).



PIPE TOOLS & VISES  
SINCE 1896

---



---

Complete, Current **Parts Sheets** for the UPC and the Water Tank found at [www.reedmfgco.com](http://www.reedmfgco.com)  
or contact REED Sales for the documents: [reedsales@reedmfgco.com](mailto:reedsales@reedmfgco.com)

Universal Pipe Cutters: RP-114  
UPC Water Tank: RP-40

---

Complete, Current **Operator's Manuals** for the UPC and the Water Tank are found at [www.reedmfgco.com](http://www.reedmfgco.com)  
or contact REED Sales for the documents: [reedsales@reedmfgco.com](mailto:reedsales@reedmfgco.com)

Universal Pipe Cutters: #57512  
UPC Water Tank: #50306

---

Current **SDS** for any products related to the UPC are found at [www.reedmfgco.com](http://www.reedmfgco.com)  
or contact REED Sales for the documents: [reedsales@reedmfgco.com](mailto:reedsales@reedmfgco.com)

Gear Grease  
Air Line Oil / Air Lube

---

---

## UPC TRAINING VIDEOS

---

<http://videos.reedmfgco.com/upc>

UPC Videos



---

Videos de capacitación por UPC

Cortatubos UPC



PIPE TOOLS & VISES  
SINCE 1896

---

Reed Manufacturing  
1425 West 8th Street  
Erie, PA 16502 USA

**QUALITY**  
& **Service**  
that Last a Lifetime

Phone: 800-666-3691 or +1-814-452-3691  
[reedsales@reedmfgco.com](mailto:reedsales@reedmfgco.com)  
[www.reedmfgco.com](http://www.reedmfgco.com)

0621-50498